

EN | **Calorimeters**

The World of Calorific Value
Determination

IKA

analytical equipment
designed for scientists

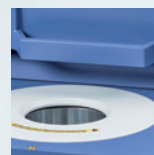

We're all fired up about how to make your life easier!

Liquids or solids, a low or high sample throughput, for standards compliance or for checking purposes - IKA has the right high-quality calorimeter for determining calorific values, for any requirement and any laboratory environment. Fast, reliable analyses, accuracy and stability over a long service life - this is what makes our calorimeters intriguing and dependable companions in everyday laboratory work.

Personalized Application Advice

You can test all the calorimeters yourself at the IKA Application Center. Our experts will analyze your combustion processes and work out with you the best way to combust the samples in your laboratory. Call us at [00 8000 4522777](tel:008004522777) or send us an e-mail to applicationsupport@ika.de

Worldwide Service



To opt for an IKA calorimeter is also to opt for the excellent IKA technical service in your region. Our team is available worldwide for your service and application needs. Spare parts for your calorimeter are guaranteed for 10 years.

Any questions? Our service team is available for your specific requirements: [00 8000 4524357](tel:008004524357) ([00 8000 IKAHELP](tel:00800IKAHELP)) or send an email to sales@ika.de

2 year warranty*



RSD 0.05 %
- 0.15 %
max. energy
introduction
40,000 J

*1+1 years after registering at www.ika.com/register, wearing parts excluded

Innovative Calorimeter Portfolio

They have differing levels of automation; they are ideal for small or large laboratories, for numerous industries, and for educational purposes. But they all measure accurately, correctly and deliver precise results: our four calorimeters, available in various application packages and with a range of accessories of proven quality. This is how IKA supplies the right calorific value determination equipment for your needs.



C 1
Page 4

C 200
Page 8

C 6000
Page 12

C 7000
Page 16

Selection Guide
Page 20

AOD Decomposition
Systems
Page 22

Additional products
Page 24

C 6040 Calvin
Calorimeter PC Software
Page 26

Accessories
C1 / C 6000
Page 27

Accessories
C 200 / C 7000 / AOD
Page 28

General consumables
Page 29

From Sample to
Calorific Value
Page 30

Fields of Application
Page 32

Calorimeter standards
Page 33

FAQs
Page 34

C 1

/// The smallest calorimeter in the world

The C 1 is a tiny giant. It takes up hardly any space in the laboratory, yet offers a high degree of automation. Where there is no need for compliance with standards, however calorific values still need to be determined or processes tested with a high degree of accuracy, this calorimeter makes life so much easier. It works according to the isoperibolic principle and with a static jacket. This makes the C 1 a strong partner for industrial and testing laboratories.

It is especially popular in: the waste management industry, the foodstuffs and animal feed industry as well as in the construction materials sector.



C1 Functions

The light, easy-to-attach combustion chamber replaces the decomposition vessel with a screw cap.

The unit functions fully automatically, which makes it particularly user-friendly.

- > Automatic oxygen filling, venting and flushing
- > Automatic ignition with a fixed ignition wire and ignition energy specification
- > Automatic water filling and drainage
- > Works with a chiller (RC 2 basic) or with an existing cold water connection and a heater (C 1.20, accessory)
- > Interfaces for PC (USB-B), printer (serial interface), scales (serial interface)

C 1
Calorimeter

Your Laboratory, our C 1 Package

What kind of laboratory do you have? With us, you will certainly find the right C 1 package. For example, if you only have a cold-water connection and your samples have a high halogen content, we recommend the C 1 package 3/12. The therein contained water heater guarantees the temperature required for its operation and ensures reproducible results. The C 1.12 decomposition vessel, included in the delivery, provides the necessary corrosion protection for chlorinated samples.

What do you need? Just get in contact with us!

Packages including combustion chamber C 1.10

C 1 PACKAGE 1/10 | Ident. No. 0010002412

C 1 Calorimeter including RC 2 basic Circulating chiller

C 1 PACKAGE 2/10 | Ident. No. 0010002413

C 1 Calorimeter

C 1 PACKAGE 3/10 | Ident. No. 0010002414

C 1 Calorimeter including C 1.20 Heater

Packages including combustion chamber C 1.12

C 1 PACKAGE 1/12 | Ident. No. 0010002415

C 1 Calorimeter including RC 2 basic Circulating chiller, halogen resistant

C 1 PACKAGE 2/12 | Ident. No. 0010002416

C 1 Calorimeter, halogen resistant

C 1 PACKAGE 3/12 | Ident. No. 0010002417

C 1 Calorimeter including C 1.20 Heater, halogen resistant

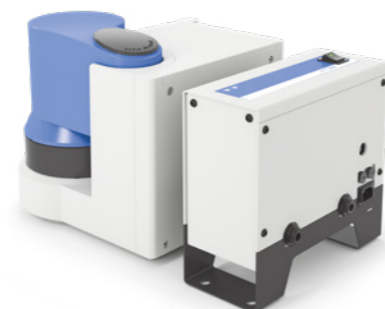
RC 2 basic
Circulating chillerC 1.20
HeaterC 1.10 / C 1.12
Combustion chamber

Technical data C 1 Calorimeter

TECHNICAL DATA

| | |
|--|------------------------------------|
| Measuring range max. | 40.000 J / 9,560 cal |
| Temperature measurement resolution | 0.0001 K |
| Oxygen operating pressure max. | 30 bar |
| Display | TFT |
| Multifunctional knob (turn / push) | Yes |
| Reproducibility static jacket (1g benzoic acid NBS39i) | 0.15 % RSD |
| Measurements per hour | 4 |
| Jacket control | Static, dry |
| Start temperature setting | 2 possibilities: 22 °C or 30 °C |
| Number of possible decomposition vessels per device | Up to 2 |

INTERFACES

| | |
|-----------------------------|-------------------------|
| Interface PC | USB-B |
| Interface Printer / Balance | 9 pin (M) RS 232 serial |

AUTOMATIC FUNCTIONS

| | |
|---|-----|
| Automatic oxygen filling, degassing and flushing | Yes |
| Automatic water filling and draining | Yes |
| Automatic combustion with ignition wire and combustion energy determination with every sample run | Yes |

COOLING WITH RC 2 BASIC CHILLER

| | |
|---|-----------|
| Cooling medium temperature min. | 18 °C |
| Cooling medium temperature max. | 29 °C |
| Cooling medium permissible operating pressure | 1.5 bar |
| Cooling medium | Tap water |
| Type of cooling | Flow |
| Flow rate min. | 50 l/h |
| Flow rate max. | 60 l/h |
| Recommended flow rate at 18 °C | 55 l/h |

GENERAL DATA

| | |
|---------------------------------|--------------------------------|
| Languages | DE, EN, FR, ES, CN, RU, PO, IT |
| Weight | 15 kg |
| Dimensions open (W × H × D) | 290 × 400 × 300 mm |
| Dimensions closed (W × H × D) | 290 × 280 × 300 mm |
| Permissible ambient temperature | 20 – 25 °C |
| Permissible relative humidity | 80 % |
| Voltage | 100 – 240 V |
| Frequency | 50 / 60 Hz |
| Power input | 150 W |

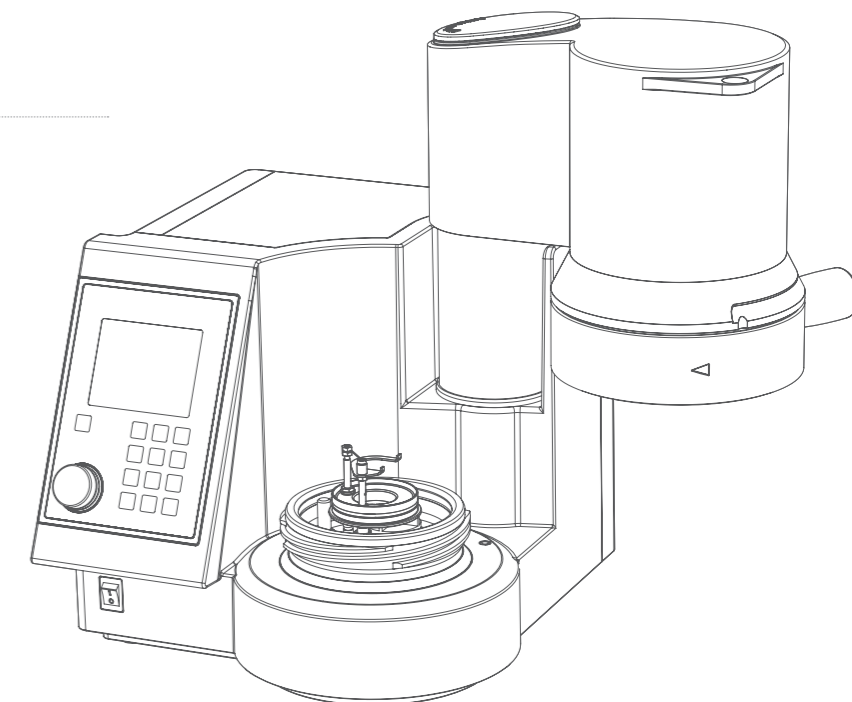

C 200

/// The perfect entry-level calorimeter

The C 200 works in compliance with several standards, saves space and is cost-effective. It consists of robust technology, making it especially low-maintenance. IKA also offers a "Student Mode" version of this combustion calorimeter, for schools, technical colleges, universities and national institutions. This is even clearer and more instructive, being used for educational purposes.

It is especially popular for: learning and educational purposes or laboratories with a small volume of samples.



C 200 Functions

Student Mode enables deep understanding of every stage of the calorimetric process.

The C 200 is particularly space-saving.

> An easy-to-use display

> Four different testing methods: isoperibolic, manual, dynamic and time-controlled

| | |
|---------------------|--------------|
| isoperibolic | up to 17 min |
| dynamic | up to 8 min |
| manual (isoperibol) | up to 17 min |
| time-controlled | up to 14 min |

> Monitoring and visualization of the measurement process and management of measurement data using the C 6040 CalWin calorimeter software (accessory)

> GOST-certified

Your Laboratory, our C 200 Package

The C 200 auto and halogen-resistant C 200 h auto packages enable the C 200 to be operated with a completely automated water circuit. Water circulates in a closed circuit and is kept at a constant temperature by the RC 2 basic circulation chiller. This reduces test preparation time for the user in the laboratory and leads to reproducible results.

What do you need? Just get in contact with us!

C 200 Packages

C 200 PACKAGE | Ident. No. 0008802500

C 200 Calorimeter, C 5010 Decomposition vessel, C 248 Oxygen filling station

C 200 H PACKAGE | Ident. No. 0008803700

C 200 Calorimeter, C 200.2 Conversion kit for C 5012, C 5012 Decomposition vessel, halogen resistant, C 248 Oxygen filling station

C 200 auto Packages

C 200 AUTO PACKAGE | Ident. No. 0010002379

C 200 Calorimeter, RC 2 basic Circulating chiller, C 5010 Decomposition vessel, C 200.RC Set of hoses

C 200 H AUTO PACKAGE | Ident. No. 0010002387

C 200 h Calorimeter, RC 2 basic Circulating chiller, C 5012 Decomposition vessel, halogen resistant, C 200.RC Set of hoses



C 248
Oxygen filling station

C 5010 / C 5012
Decomposition vessel



C 200.2
Conversion kit for C 5012

C 200 Packages



C 200
Calorimeter

C 200 auto Packages



RC 2 basic
Circulating chiller

C 200.RC
Set of hoses

Technical data C 200 Calorimeter

TECHNICAL DATA

| | |
|---|---|
| Measuring range max. | 40,000 J / 9,560 cal |
| Temperature measurement resolution | 0.0001 K |
| Measuring modes | > Isoperibol > Manual (Student mode) > Dynamic > Time controlled |
| Reproducibility (1g benzoic acid NBS39i) | 0.1 % RSD |
| Operation time | Isoperibol 17 min Dynamic 8 min Time controlled 14 min |
| Working temperature max. | 25 °C |
| Number of possible decomposition vessels per device | Up to 4 |
| Decomposition vessel | C 5010 / C 5012 |

INTERFACES

| | |
|---------|---------------|
| PC | RS 232 serial |
| Printer | Centronix |

AUTOMATIC FUNCTIONS

| | |
|--------------------------------------|-------------------|
| Automatic water filling and draining | Yes |
| Ignition | Yes (manual - No) |

COOLING WITH RC 2 BASIC CHILLER

| | |
|---|-----------|
| Cooling medium | Tap water |
| Type of cooling | Flow |
| Cooling medium permissible operating pressure | 2 bar |

GENERAL DATA

| | |
|--|--------------------|
| Weight | 21 kg |
| Dimensions (W x H x D) | 400 x 400 x 400 mm |
| Permissible ambient temperature | 20 – 25 °C |
| Permissible relative humidity | 80 % |
| Voltage | 100 – 240 V |
| Frequency | 50 / 60 Hz |
| Power input | 120 W |
| Protection class according to DIN EN 60529 | IP 20 |

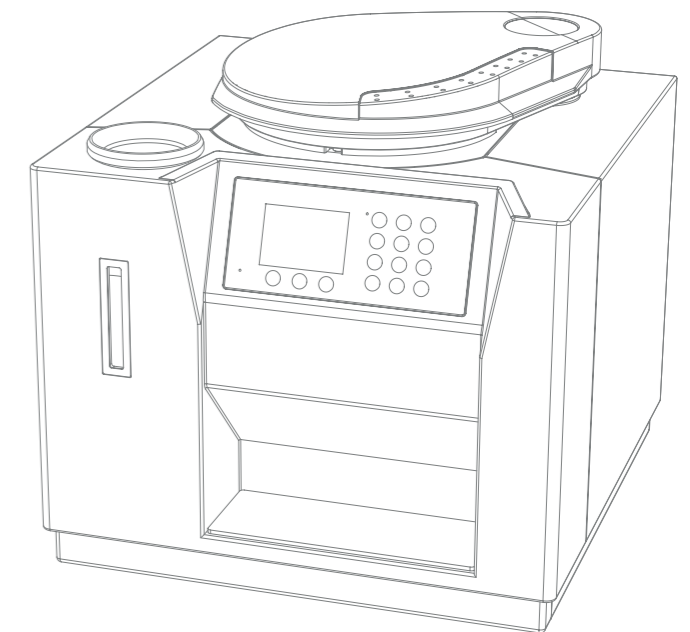

C 6000

/// An evolution in calorimetry

The champion of modern calorimetry has been developed even further. The new C 6000 has an intuitive touch screen with unique user guidance. The high level of automation simplifies everyday work and enables high sample throughput. The strictest adherence to standards gives rise to the most accurate repeatable results in the world and guarantees the desired assurance.

Especially suitable for: sectors in which adherence to standards is a prerequisite and a large number of samples need to be measured.

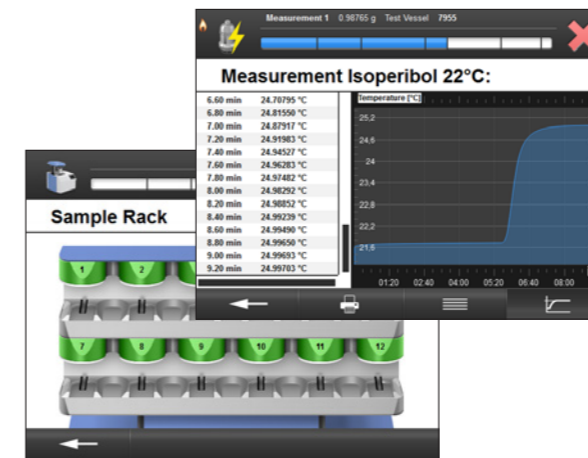

C 6000 Functions

The new movement-sensitive touch screen guarantees even easier, more intuitive use.

The C 6000 easily meets all standards.



- > Easily-accessible USB interface for simple, enhanced data management
- > Ethernet interface for data management via an FTP server
- > Spherically-shaped decomposition vessel for improved heat transfer and shorter measurement times
- > Powerful device software with a control chart view of calibration and calorific value corrections, compliant with globally-applicable standards
- > RFID technology for decomposition vessel detection
- > Inverted crucible holder for easier measurement preparation
- > 3 starting temperatures: 22 °C, 25 °C, 30 °C



Your Laboratory, our C 6000 Package

The C 6000 is available in global standards or isoperibolic versions. Thanks to the innovative technology of the C 6000 global standards, conventional adiabatic as well as isoperibolic measurement methods can be used. This makes it the only device with such a high level of automation in the market. Both variants also have a fast dynamic mode.

What do you need? Just get in contact with us!

C 6000 global standards Packages

C 6000 PACKAGE 1/10 | Ident. No. 0010004520

C 6000 Calorimeter, C 6010 Decomposition vessel , RC 2 basic Circulating chiller

C 6000 PACKAGE 1/12 | Ident. No. 0010004521

C 6000 Calorimeter, C 6012 Decomposition vessel, halogen resistant, RC 2 basic Circulating chiller

C 6000 Package 2/10 | Ident. No. 0010004522

C 6000 Calorimeter, C 6010 Decomposition vessel

C 6000 Package 2/12 | Ident. No. 0010004523

C 6000 Calorimeter, C 6012 Decomposition vessel, halogen resistant

C 6000 isoperibol Packages

C 6000 Package 1/10 | Ident. No. 0010004524

C 6000 Calorimeter, C 6010 Decomposition vessel, RC 2 basic Circulating chiller

C 6000 Package 1/12 | Ident. No. 0010004525

C 6000 Calorimeter, C 6012 Decomposition vessel, halogen resistant, RC 2 basic Circulating chiller

C 6000 Package 2/10 | Ident. No. 0010004526

C 6000 Calorimeter, 6010 Decomposition vessel

C 6000 Package 2/12 | Ident. No. 0010004527

C 6000 Calorimeter, C 6012 Decomposition vessel, halogen resistant



Technical data C 6000 Calorimeter

TECHNICAL DATA

| | |
|---|---|
| Measuring range max. | 40,000 J / 9,560 cal |
| Temperature measurement resolution | 0.0001 K |
| Oxygen operating pressure max. | 40 bar |
| Display | TFT with touch screen |
| Measuring modes | > Isoperibol 22 / 25 / 30 °C > Dynamic 22 / 25 / 30 °C > Adiabatic 22 / 25 / 30 °C |
| Reproducibility (1g benzoic acid NBS39i) | 0.05 to 0.15 % RSD |
| Measurements per hour | Isoperibol 4 Dynamic 6 Adiabatic 5 |
| Number of possible decomposition vessels per device | Up to 4 |
| Decomposition vessels | C 6010 / C 6012 |

INTERFACES

| | |
|---------|-------------------------|
| PC | 9 pin (M) RS 232 serial |
| Printer | USB-B, Ethernet |
| Balance | 9 pin (M) RS 232 serial |

AUTOMATIC FUNCTIONS

| | |
|--|-----|
| Automatic water filling and draining | Yes |
| Automatic oxygen, venting, flushing | Yes |
| Ignition and ignition energy determination for each experiment | Yes |

COOLING WITH RC 2 BASIC CHILLER

| | |
|---|---------|
| Cooling medium temperature min. | 12 °C |
| Cooling medium temperature max. | 27 °C |
| Cooling medium permissible operating pressure | 1.5 bar |

CALORIMETER STANDARDS

| | | |
|-----------------------|--------------------------|------------|
| Analysis according to | GB T213 | DIN 51900 |
| | DIN EN ISO 1716 | ASTM D240 |
| | DIN CEN TS 14918 | ASTM D4809 |
| | DIN EN 15170 ISO 1928 | ASTM D5865 |

GENERAL DATA

| | |
|--|--------------------|
| Weight | 29 kg |
| Dimensions (W × H × D) | 500 × 450 × 450 mm |
| Permissible ambient temperature | 20 – 30 °C |
| Permissible relative humidity | 80 % |
| Voltage | 220 – 240 V |
| Frequency | 50 / 60 Hz |
| Power input | 1,700 W |
| Protection class according to DIN EN 60529 | IP 20 |

C 7000

/// When it needs to be fast

The C 7000 is the first calorimeter from IKA to have a completely dry design. It measures the calorific values of liquid and solid samples directly in the decomposition system. Depending on the selected pre-testing time, the measurement times can be reduced to 3 to 7 minutes. The system can handle up to eight different decomposition vessels from one set of coding. This makes timely decisions and fast progress with work processes possible.

It is especially popular in: the waste and disposal industry



C 7000 Functions

The dry device design enables extra-fast measurement in just a few minutes.

The especially robust design ensures a long service life, even under tough conditions.

> Precise, repeatable calorific value determination according to ISO 1928, DIN CEN/TS 16023, DIN EN 15400, DIN EN 15170, DIN EN ISO 18125

> Up to eight decomposition vessels per device can be used



Your Laboratory, our C 7000 Package

The C 7000 is available either as a variant with a standard decomposition vessel (Set 1) or with a halogen-resistant decomposition vessel (Set 2) for samples with a particularly high halogen content, such as those, which especially occur in the waste industry.

What do you need? Just get in contact with us!

C 7000 SET 1 | Ident. No. 0008800900

C 7000 Measurement cell, C 7002 Cooling system, C 48 Oxygen station, C 7010 Decomposition vessel

C 7000 SET 2 | Ident. No. 0008801400

C 7000 Measurement cell, C 7002 Cooling system, C 48 Oxygen station, C 7012 Decomposition vessel, halogen resistant

Technical data C 7000 Calorimeter

TECHNICAL DATA

| | |
|---|-----------------------|
| Measuring range max. | 30,000 J |
| Temperature measurement resolution | 0.0001 K |
| Oxygen operating pressure max. | 40 bar |
| Display | LED |
| Measuring mode | Double dry (ISO 1928) |
| Double dry reproducibility (1g benzoic acid NBS39i) | 0.2 % RSD |
| Working temperature max. | 30 °C |
| Operation time double dry approx. | 3 min |
| Number of possible decomposition vessels per device | 8 |
| Decomposition vessels | C 7010 / C 7012 |

INTERFACES

| | |
|---------|---------------|
| PC | RS 232 serial |
| Printer | Centronix |
| Balance | RS 232 serial |

COOLING

| | |
|---|-----------|
| Type of cooling | Flow |
| Cooling medium | Tap water |
| Cooling medium temperature min. | 12 °C |
| Cooling medium temperature max. | 30 °C |
| Cooling medium permissible operating pressure | 9 bar |

GENERAL DATA

| | |
|---------------------------------|--------------------|
| Weight | 43 kg |
| Dimensions (W × H × D) | 310 × 395 × 490 mm |
| Permissible ambient temperature | 18 – 30 °C |
| Permissible relative humidity | 80 % |
| Voltage | 220 – 240 V |
| Frequency | 50 / 60 Hz |
| Power input | 260 W |





| TECHNICAL DATA | C 1 | C 6000 ISOPERIBOL | C6000 GLOBAL STANDARDS |
|--|---|---|---|
| Calorimeter standards | DIN 51900 ISO 1928 DIN CEN/TS 16023 DIN SPEC 19524 | DIN 51900 DIN CEN/TS 16023 DIN SPEC 19524 DIN EN 15400 DIN EN ISO 1716 DIN EN ISO 9831 DIN EN 15170 DIN EN ISO 18125 DIN EN 14918 ISO 1928 ASTM D5865 ASTM D5468 ASTM D4809 ASTM D240 GB T213 | DIN 51900 DIN CEN/TS 16023 DIN SPEC 19524 DIN EN 15400 DIN EN ISO 1716 DIN EN ISO 9831 DIN EN 15170 DIN EN ISO 18125 DIN EN 14918 ISO 1928 ASTM D5865 ASTM D5468 ASTM D4809 ASTM D240 GB T213 |
| Measuring range max. | 40,000 J | 40,000 J | 40,000 J |
| Temperature measurement resolution | 0.0001 K | 0.0001 K | 0.0001 K |
| RSD (NIST benzoic acid NBS39i) | 0.15 % | 0.05 to 0.15 % | 0.05 to 0.15 % |
| Measuring mode | Static Jacket (Regnault-Pfaundler) | Isoperibol Dynamic | Isoperibol Dynamic Adiabatic |
| Measuring per hour | 4 | Isoperibol 4 Dynamic 6 | Isoperibol 4 Dynamic 6 Adiabatic 5 |
| Start temperature | 22 °C, 30 °C | 22 °C, 25 °C, 30 °C | 22 °C, 25 °C, 30 °C |
| Preparation time for operator | 1 min | 1 min | 1 min |
| Decomposition vessel identification | Manual | Automatic | Automatic |
| INTERFACES | | | |
| PC | USB-B or RS 232 | RS 232 | RS 232 |
| Printer | RS 232 | USB-B, RS 232 serial or ethernet | RS 232 |
| Balance | RS 232 | RS 232 | RS 232 |
| Sample rack | No | Yes | Yes |
| AUTOMATIC FUNCTIONS | | | |
| Automatic water filling and draining | Yes | Yes | Yes |
| Automatic oxygen filling, venting, flushing | Yes | Yes | Yes |
| Ignition and ignition energy determination for each experiment | Yes / Yes | Yes / Yes | Yes / Yes |
| GENERAL DATA | | | |
| Languages | DE, EN, FR, ES, CN, RU, PL, IT | DE, EN, FR, ES, CN, RU, PL, IT | DE, EN, FR, ES, CN, RU, PL, IT |
| Dimensions open (W x H x D) | 290 x 400 x 300 mm | 500 x 620 x 450 mm | 500 x 620 x 450 mm |
| Dimensions closed (W x H x D) | 290 x 280 x 300 mm | 500 x 425 x 450 mm | 500 x 425 x 450 mm |
| Weight | 15 kg | 29 kg | 29 kg |



| TECHNICAL DATA | C 200 (C 200 auto) | C 7000 |
|--|---|--|
| Calorimeter standards | DIN 51900 DIN CEN/TS 16023 DIN SPEC 19524 DIN EN 15400 DIN EN ISO 1716 DIN EN 14918 DIN EN ISO 18125 ISO 1928 ASTM D240 ASTM D4809 ASTM D5865 ASTM D5468 | ISO 1928 DIN CEN/TS 16023 DIN SPEC 19524 DIN EN 15400 DIN EN 15170 |
| Measuring range max. | 40,000 J | 30,000 J |
| Temperature measurement resolution | 0.0001 K | 0.0001 K |
| RSD (NIST benzoic acid NBS39i) | 0.10 % | 0.20 % |
| Measuring mode | Isoperibol Dynamic | Double dry |
| Measuring per hour | Isoperibol 3 Dynamic 6 Manual 3 Time-controlled 4 | 6 – 20 |
| Start temperature | 18 °C – 25 °C | max. 30 °C |
| Preparation time for operator | 5 min (auto 2 min) | 2 min |
| Decomposition vessel identification | Manual | Automatic |
| INTERFACES | | |
| PC | RS 232 | RS 232 |
| Printer | Centronix | Centronix |
| Balance | RS 232 | RS 232 |
| Sample rack | No | No |
| AUTOMATIC FUNCTIONS | | |
| Automatic water filling and draining | No (auto: Yes) | Not applicable |
| Automatic oxygen, venting, flushing | No | No |
| Ignition and ignition energy determination for each experiment | Yes (manual No) / No | Yes / No |
| GENERAL DATA | | |
| Languages | DE, EN, FR, ES, CN | DE, EN, FR |
| Dimensions open (W x H x D) | 400 x 470 x 400 mm | 310 x 500 x 490 mm |
| Dimensions closed (W x H x D) | 400 x 400 x 400 mm | 310 x 395 x 490 mm |
| Weight | 21 kg | 43 kg |

AOD Decomposition System

Decomposition under oxygen (O₂) and pressure is known as active oxidative decomposition, or AOD. As with the calorimeter decomposition vessel, the liquid or solid sample is fully combusted in the AOD system. Unlike conventional decomposition vessels, the innovative AOD 1 has both chlorine resistance and a catalytically-active interior surface. The catalysts encourage chemical reactions during the combustion process and ultimately lead to increased recovery rates with halogens and sulfur.

A large number of global standards for a vast range of sample materials describes this bomb decomposition technology (e.g. DIN 51727, DIN 51723, DIN EN 14582, DIN EN ISO 16994, DIN EN 15408, ASTM D 4208).



Technical data AOD

TECHNICAL DATA

| | |
|---------------------------------|------------------------|
| Decomposition time | 3 min |
| Chamber volume | 210 ml |
| Pressure max. | 195 bar |
| Core temperature max. | 1,200 °C |
| Oxygen operating pressure max. | 40 bar |
| Permissible ambient temperature | min. 5°C max. 40 °C |

GENERAL DATA

| | |
|--|--------------------|
| Weight | 10 kg |
| Dimensions (W x H x D) | 400 x 480 x 260 mm |
| Permissible relative humidity | 80 % |
| Voltage | 230 V |
| Frequency | 50 / 60 Hz |
| Power input | 45 W |
| Protection class according to DIN EN 60529 | IP 20 |



AOD 1.3 Protection device
Ident. No. 0003308000



AOD 1.13 Remote ignition head
Ident. No. 0003348100

AOD 1 DECOMPOSITION SYSTEM | Ident. No. 0008801300

AOD 1.1 Decomposition vessel, C 48 Oxygen station,
AOD 1.2 External ignition unit, AOD 1.11 Control standard (50 ml)

The operator has to ensure a proper and safe use of the AOD 1.1 decomposition vessel by providing appropriate safeguarding equipment. The system could be equipped with our AOD 1.3 protective device. If another safeguarding equipment is already in place, the use of the remote ignition head AOD 1.13 is required. Both are available as accessories separately and are not included in the package (see page 32).

RC 2 basic circulating chiller

The RC circulating chillers provide an even starting temperature for any calorimetric measurement. This improves the reproducibility of measurement results. The RC 2 basic is a highly efficient recirculating chiller with a powerful 400 W refrigeration capacity for chilling down to -20°C. Up to 2.5 liters of thermofluid for the external chilling circuit can be supplied from the high-quality insulated 4-liter reservoir without refilling. The speed-controlled PEEK pump enables indirect, continuous setting of the maximum pressure and volume flow.

The excellent temperature constancy of $\pm 0.1\text{K}$ (at -10°C) is sufficient for even challenging applications. The integrated filling funnel and outlet valve enable safe, clean handling of the coolant and the air filter is easy to clean thanks to the easy-to-open front flap.

The RC circulating chillers are an ideal addition to the C 1, C 200, C 6000 and C 7000 calorimeters. They naturally also cool other external analysis equipment quickly and efficiently.



RC 2 basic circulating chiller

Ident. No. 0004171000

IKA Oven 125 basic dry - glass

Easy sample preparation: The universal IKA air circulation drying cabinet ensures dependable drying of your samples. In this way, you can be sure that the water content in the sample cannot falsify the result of the calorific value determination. It is also suitable for all other temperature controlling, drying, aging and heating processes in the laboratory.

Whether used in industry, for training, research or quality control, fast heating times and precise temperature control guarantee repeatable results. Special odorless insulation also ensures lower operating costs. The drying cabinet can be controlled over a USB interface and test parameters can be set.



IKA Oven 125 basic dry - glass

Ident. No. 0020003956

IKA Pilotina dry milling system

The Pilotina dry mill has two milling systems for homogenizing sample material: a cutting mill system for soft, sticky, elastic or fibrous materials such as plant parts, plastic and feed pellets; and an impact milling system for hard and brittle materials such as coal, glass, ores or seeds. The degree of fineness can be set precisely.

The Pilotina achieves excellent crushing quality in a short time and therefore ensures high representation for your samples. Thanks to the powerful, frequency-controlled 3 kW drive with a digital display, the circumferential speed can be optimally set to the respective milling process for your application requirements. The smart device design also enables easy, fast cleaning.



IKA Pilotina MU

Ident. No. U105421

TECHNICAL DATA PILOTINA MU

| | |
|--|----------------------|
| Motor power | 3 kW |
| Speed range | 1,500 – 4,500 rpm |
| Speed indication | Digital |
| Capacity (depending on the final fineness) | approx. 60 – 80 kg/h |
| Overload protection | Yes |
| Circumferential speed | 9 – 34 m/s |
| Max. charging hardness | 3 bzw. 6 Mohs |
| Approx. max. charging size | 65 x 60 or 25 mm |
| Dimensions, approx. (W x H x D) | 495 x 830 x 740 mm |
| Weight, approx. | 80 kg |
| Permissible ambient temperature | 5 – 35 °C |
| Permissible relative humidity | 80 % |
| Protection type | IP 55 |

CalWin C 6040 Evaluation Software

Using the CalWin C 6040 control and analysis software for your IKA calorimeter, you can save, analyze and easily transfer even larger volumes of data to your laboratory information management system (LIMS). Multiple devices can also be controlled by the software. It functions ideally in conjunction with the new C 6000 global standards, the C 6000 isoperibol, C 1, the C 200 (Firmware 2.0) as well as C 5000 (Firmware 2.22) and the C 2000 (Firmware 2.22).



> Data management via a Microsoft SQL Server is possible

> Clear display of all measurements, results and connected calorimeters on a single screen

> Printing and storage of calibration logs with a control chart view

> Library and grouping function with enhanced data filter options

> Correction calculations to determine the heating value according to ISO, ASTM, DIN, GB, GOST and other standards

> Data transfer into preconfigured Excel worksheets (can be reconfigured by the user)

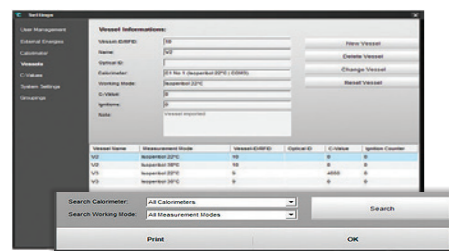

CALWIN C 6040 EVALUATION SOFTWARE |

Ident. No. 0004040500

Scope of delivery: DVD, RS 232 calorimeter connecting cable and RS 232-USB adapter

CALWIN C 6040 SYSTEM REQUIREMENTS

Windows XP (SP2), Windows Vista, Windows 7, Windows 8, Windows 10, at least one free USB connection or one RS 232 (9-pin sub-D (M)), serial interface, processor min. 1.6 GHz (single core processor), 2 GB RAM; 2.5 GB hard disk space, DVD-ROM drive.

Accessories C 1 / C 6000



C 6010 Decomposition vessel
Standard vessel
Ident. No. 0003770000



C 1.12 Combustion chamber
Halogen resistant
Ident. No. 0004500400



C 6030 Venting station
Adjustable valve allows controlled venting of combustion gases after decomposition. Suitable for decomposition vessel C 6010 and C 6012
Ident. No. 0004504100



C 29 Pressure gauge, oxygen
To reduce the oxygen pressure of the bottle to 30 bar
Ident. No. 0000750200



C 21 Pelleting press
Manual pellet press for powders; good combustible substances
Ident. No. 0001605300



C 5020 Sample rack
For reliable registration and management of up to 12 samples directly on the calorimeter - suitable for C 6000
Ident. No. 0007145000



C 1.50 Dot matrix printer
Equipped with serial interface, printer cable, paper rolls and ink cartridge – suitable for calorimeter C 6000 and C 1.
Ident. No. 0004500600



C 27 Calorimeter preparation set
Ident. No. 0004579700

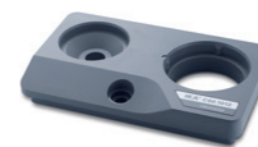

C 60.1012 Organizer
Suitable for C 6010 and C 6012
Ident. No. 0004504200



C 1.1012 Organizer
Suitable for C 1.10 and C 1.12
Ident. No. 0004500700



C 5010.8 Crucible holder small
Ident. No. 0004579800

Find more accessories on www.ika.com

Accessories C 200 / C 7000 / AOD



C 5010 Decomposition vessel
Standard vessel
Material: Stainless steel with fixed ignition wire. Can be converted to use with C 14 combustible crucible
Ident. No. 0007114000



C 5010.4 Attachment for combustible crucible C 14
Only in combination with C 5010, C 5012, C 7010, C 7012 und AOD 1.1 decomposition vessels.
Ident. No. 0003016900



C 5030 Venting station
Adjustable valve allows controlled venting of combustion gases after decomposition. Suitable for decomposition vessel C 5010 und C 5012
Ident. No. 0007198000



C 200.RC Set of hoses
This accessory is used to automate the water cycle of the C 200 calorimeter. It is designed to particularly work with our IKA recirculating chillers RC 2 basic and RC 2 control.
Ident. No. 0020010835



C 7012 Decomposition vessel, halogen resistant
Material: halogen resistant stainless steel with catalytic activated inner surface. Especially for combustion / decomposition of halogen and sulfur containing samples
Ident. No. 0003017000



C 7010.8 Venting handle
For transportation and degassing of the decomposition vessels C 7010 and C 7012
Ident. No. 0007095000



C 7002 Cooling system (230 V)
Cooling through peltier elements; less consumption of water
Ident. No. 0007011000



C 48 Oxygen station
For a precise and reproducible oxygen filling of the decomposition vessels C 7010 and C 7012
Ident. No. 0001560000



C 723 Benzoic acid, blister package
50 pieces; 0.5 g per pellet; Benzoic acid included, with analysis certificate from a DAkkS accredited laboratory with ISO 17025 certificate
Ident. No. 0003243000



C 1.101 Set of spare parts
Ident. No. 0004502200



C 43 Benzoic acid NBS 39i
High pure benzoic acid powder; 30 g; standard reference material with certificate of the National Institute of Standards & Technology (NIST), USA
Ident. No. 0000750600



C 1.103 Ignition wire
5 pieces; kantal ignition wire for up to 100 ignitions each; especially for decomposition vessels C 6010 and C 1.10
Ident. No. 0004579300



C 710.4 Cotton thread, cut to length
500 pieces, cut to length. With known calorific value
Ident. No. 0001483700



C 15 Paraffin strips
600 pieces; 45 mm x 3 mm; especially for hard flammable, water containing samples
Ident. No. 0003131100



C 710.2 Set of VA combustion crucibles
25 pieces; Ø 23 mm x 16 mm high; 25 combustions per piece
Ident. No. 0001483500



AOD 1.11 Control standard
50 ml; mineral oil with certified sulphur and chlorine content. For checking AOD decomposition and peripheral detection devices
Ident. No. 0003044000



AOD 1.1 FZ Decomposition vessel
Ident. No. 0003303000



AOD 1.3 Protection device
Recommended protection device for the AOD 1 when following European pressure equipment directive 97 23 EC.
Ident. No. 0003308000



AOD 1.13 Remote ignition head
Only required if another protection device is already in place, to ignite the vessel remotely.
Ident. No. 0003348100

Find more accessories on www.ika.com



C 6 Quartz crucible, big
Ø 26 mm x 18 mm high; to fill in a higher amount of material with low calorific value; especially for samples with high ash content; C 5010.5 crucible pan, big is required
Ident. No. 0000355100



C 10 Acetobutyrate capsules
100 pieces; with known calorific value; to fill in samples with volatile compounds; not hygroscopic
Ident. No. 0000750000

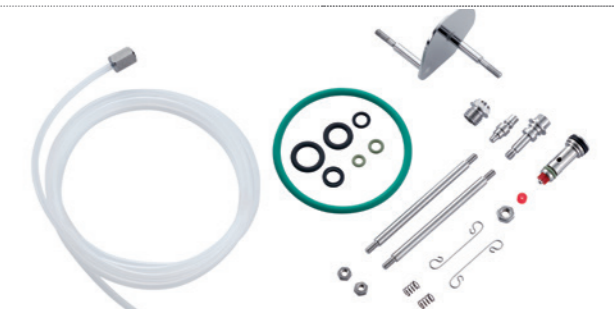

C 6000.10 Set of spare parts
For C 6000 calorimeter and C 6010 decomposition vessel; includes various o-rings and seals; a ventilation hose with capillary; two ignition and ground electrodes; 10 ignition wires; a complete piston; a nozzle; two compression springs; spare Hastelloy nuts
Ident. No. 0004504300

From Sample to Calorific Value

When using a combustion calorimeter, the heat that is created from a sample is measured during its combustion under controlled conditions. In the decomposition vessel - the so-called bomb - the sample is burned with an excess of oxygen. The resulting heat is given off into the environment and measured. To prevent disruptive external temperature influences, the system is surrounded with a jacket.

The Measurement Process

About one gram of a solid or a liquid is weighed out in a crucible and placed in the "bomb". The sample in the crucible is connected to the ignition wire by a cotton thread. The vessel is then filled with oxygen (30 bar) and the sample combusted. During the combustion process, the core temperature of the crucible can increase to 1,000°C. This also increases the pressure. All organic material is combusted under these conditions.

The heat produced during the combustion process can now be determined. The measurement result is then designated as the calorific value.



C 6000 global standards

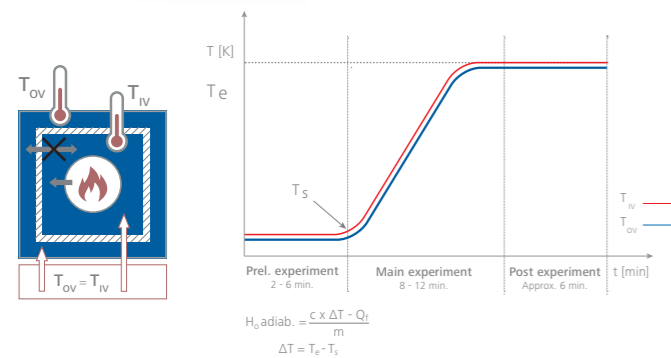

Adiabatic Measurement Method

With an adiabatic calorimeter, the temperature in the jacket (T_{ov}) is kept the same as the temperature inside the vessel (T_{iv}) throughout the test. This reasonably approaches "perfect insulation". Unlike the isoperibolic calorimeter, no correction calculations are required.



C 6000 global standards
C 6000 isoperibol
C 200

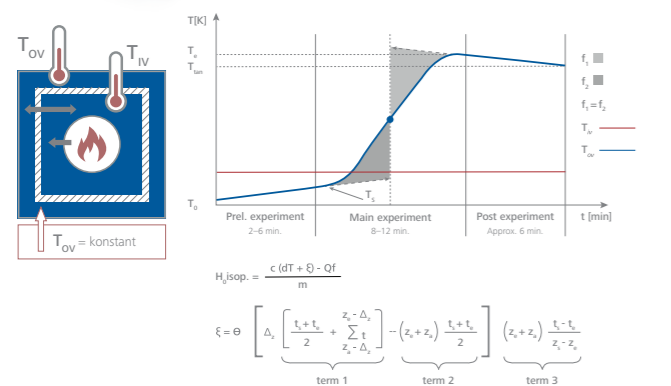

Isoperibolic Measurement Method

With an isoperibolic calorimeter, the temperature in the jacket (T_{ov}) is kept constant throughout the test. This results in a lower heat flow. Environmental factors are minimized through air-conditioning to keep the effects of room temperature fluctuations as small as possible. However, after the test, a correction factor (Regnault-Pfaundler = ξ) that takes the heat flow into account is calculated.



C 6000 global standards
C 6000 isoperibol
C 200

Dynamic Measurement Method

The IKA dynamic processes are essentially shorter versions of the original adiabatic and/or isoperibolic measurement processes. However, the measurement results still comply with the relative standard deviation (RSD) for the official standards.



C 1

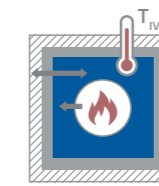

Static jacket Calorimeter

Static Jacket Measurement Method

In the static jacket calorimeter, similar conditions occur as with the isoperibolic calorimeter, the critical difference being that the jacket is not controlled - it is static. On the C 1, the aluminum jacket is the pressure-retaining container. There is still an insulating layer of air around the calorimeter housing and the jacket. When the temperature profile is considered, the behavior of the C 1 is similar to that of an isoperibolic measurement process. The same correction calculation can be used here as for the isoperibolic calorimeter according to Regnault-Pfaundler.



C 7000

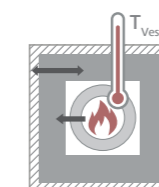

Doppel-trockenes Calorimeter

Double-dry Measurement Method

With the double-dry calorimeter, the temperature increase in the decomposition vessel itself is measured. The latter is surrounded by a large aluminum jacket. The combustion heat is thus measured directly and not transferred to the water in the inner vessel, as with conventional calorimeters. This saves a lot of time. The result - depending on the chosen pre-test time - is a measurement period of just 3 minutes per test. This method is predominantly used in the waste management industry. The actual measurement process behaves similarly to an isoperibolic measurement, albeit with a comparatively very large drift in pre- and post-testing.

Fields of Application

Calorific values play a role in a diverse range of industries. Our product portfolio is ideally oriented for calorific value determination in the following fields of application:



Coal and Coke / Power Plants

- Anthracite coal
- Hard coal
- Brown coal
- Bituminous coal
- Coke



Cement

- Coke
- Tires
- Animal flour
- Mixed waste material



Petroleum

- Jet fuel
- Kerosene
- Liquid fuels
- Gasoline
- Oil
- Bio-fuels



Waste Management / Recycling

- Tetra-pack
- PVC powder
- Printed circuit board
- Lacquer
- Waste solvent



Agriculture (Fodder)

- Forage crops
- Fodder for cats, dogs, cows, sheep, pigs, chicken
- Animal urine and droppings



Food

- Noodles
- Dried fruit
- Fish
- Milk
- Chocolate
- Cheese



Construction and Building Materials

- Fleece
- Insulation material
- Styrofoam
- Mortar
- Rock wool

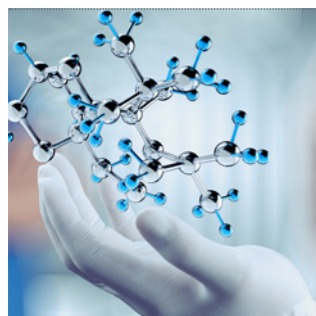

Universities and Research Institutes

- Teaching thermodynamics
- Enthalpy studies
- Airplane covering
- Ecological studies



Biomass

- Wood
- Wood pellets
- Saw dust
- Grass
- Corn
- Bio-fuels

Calorimeter Standards

ASTM – D240

Standard test method for heat of combustion of liquid hydrocarbon fuels by bomb calorimeter

ASTM – D4809

Standard test method for heat of combustion of liquid hydrocarbon fuels by bomb calorimeter (precision method)

ASTM – D5865

Standard test method for gross calorific value of coal and coke

ASTM – D5468

Standard test method for gross calorific and ash value of waste materials

ASTM – E711

Standard test method for gross calorific value of refuse-derived fuel by bomb calorimeter

DIN EN ISO 9831

Animal feeding stuffs, animal products and feces or urine – determination of gross calorific value

DIN EN 14582:2007

Characterization of waste - halogen and sulfur content oxygen combustion in closed systems and determination methods

DIN 51900 – 1

Testing of solid and liquid fuels - determination of gross calorific value by the bomb calorimeter and calculation of net calorific value. Part 1: Principles, apparatus, methods

DIN 51900 – 2

Testing of solid and liquid fuels - Determination of the gross calorific value by the bomb calorimeter and calculation of the net calorific value - Part 2: Method using isoperibol or static, jacket calorimeter

DIN 51900 – 3

Testing of solid and liquid fuels - Determination of gross calorific value by the bomb calorimeter and calculation of net calorific value - Part 3: Method using adiabatic jacket

GB/T 213 – 2008

Calorie testing method of coal

ISO 1928

Solid mineral fuels
Determination of gross calorific value by the bomb calorimetric method and calculation of net calorific value

ISO 1716

Reaction to fire tests for building products

JIS M 8814

Coal and coke: determination of gross calorific value by the bomb calorimetric method and calculation of net calorific value

FAQs

Which calorimeter is most suitable for my application and requirements?

The main questions that should be answered are as follows:

1. How many experiments do you plan on conducting in a day?
2. Are there any standards that have to be followed, such as ISO, ASTM, DIN, GB, GOST etc.?
3. Do samples contain halogens and sulphur and if so, what is the concentration (approximately)?
4. Is it required to analyze the halogens and sulphur content after the calorimeter experiment has concluded?
5. Do you prefer any of the following methods: adiabatic, isoperibol, static jacket isoperibol, dry or dynamic?

How do I know my calorimeter is still in calibration?

Most customers operate their calorimeters with control charts. After calibrating the unit, check runs are performed with benzoic acid, for instance. The results of these check runs have to match the certified calorific value of the benzoic acid within a defined range. The definition of the range is laid out in standards and the frequency of doing these checks differs from one a day, to one after and before every sample. The control charts show the performance of the unit under the previously described circumstance over a long period of time.

How often do I have to calibrate the calorimeter?

The control chart also shows when a new calibration might be required.

What are the min. and max. calorific values that I can measure with the calorimeter?

The max. allowed energy input into our calorimeters is 40,000 J. The calorific value of a sample is always expressed in energy per weight (J/g). Based on that information, you can adjust the weight of your sample such that it does not exceed 40,000 J. The energy amount created by the sample should not be significantly higher than the one obtained during calibration with benzoic acid. Our calorimeters do have a high measuring sensitivity and can detect low quantities of energy. For example, the ignition energy of 70 J can be measured with an absolute error of ± 20 J. The relative error rises naturally ($\pm 30\%$) hyperbolically the smaller the energy input is. If your sample has a very low calorific value you can also use combustion aids, since they add energy to the calorimeter to minimize the error.

When do I have to send in the decomposition vessel for high pressure inspection at IKA?

We recommend checking the vessel after 1000 experiments or after 1 year of operation, whichever comes first. During the overall inspection process we perform both a high pressure and an operating pressure test. A new certificate will be issued for the vessel after it has passed both of these tests. More detailed information can be found in the manual of your calorimeter and/or the manual of your decomposition vessel. Alternatively, you can always contact your local service department for further information and assistance.

Where do I find a list of spare parts and how many of these do I need?

We offer sets of spare parts that include parts for 1000 experiments e.g. 1 year operation. The actual amount of spare parts can vary based on the application. If a specific spare part is required, you can find further information in the service section of the operating manual. In addition, under the "Service" section of our website (www.ika.com), you can download service drawings with detailed descriptions of each part. Alternatively, you can always contact our service department for further information and assistance.

How can I get the gross and net calorific value – easily explained?

A calorimeter measures the preliminary gross calorific value of the sample. To get the gross calorific value, correction calculations are required for the acids formed during the combustion. For instance, the method of titration used to obtain the amount of nitric acid and sulphuric acid are described in detail in the standard ISO 1928. To get to the net calorific value, further corrections need to be applied concerning the amount of water that was formed during the combustion from hydrogen. Based on the state (dry, analytical moisture, as received) your sample was in before combustion, further corrections may apply. Moistures are determined by drying the samples. The Hydrogen content is usually measured with an elemental analyzer. For a more detailed explanation, we ask you to study the standards you might have to use depending on your application requirements.



Contact
sales@ika.de
for your free
demo



Subject to technical changes

IKA CALORIMETERS

IKA oxygen bomb calorimeters are the market leaders when it comes to determining the calorific values of liquid and solid samples. The selection of IKA oxygen bomb calorimeters is optimally geared towards various different demands. Calorimeters portfolio includes: C 1, C 200, C 6000 and C 7000.

IKA-Werke GmbH & Co. KG
Janke & Kunkel-Straße 10, 79219 Staufen, Germany
Phone: +49 7633 831-0, Fax: +49 7633 831-98
eMail: sales@ika.de



www.ika.com



[IKAworldwide](#) // #lookattheblue